

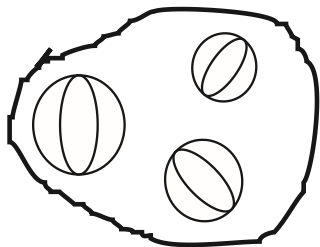

Βάζω σε κύκλο τα σχήματα που μοιάζουν.
Μετρώ πόσα είναι και γράφω τον αριθμό.

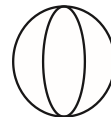

3



σφαίρες

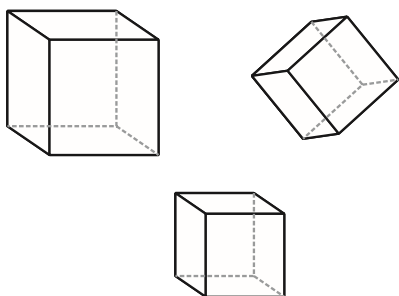

—

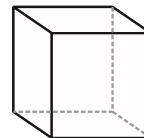

κύβοι

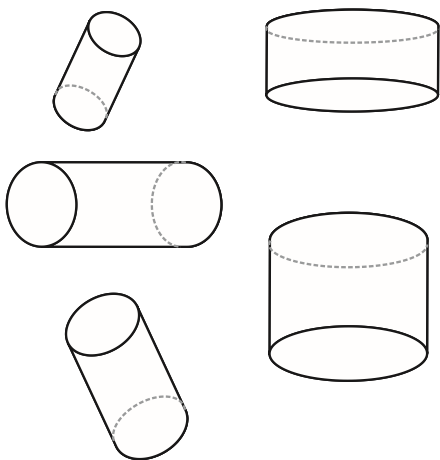

—



κύλινδροι

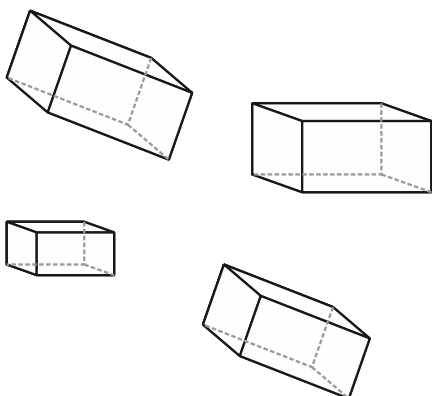

—

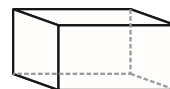

στερεά
ορθογώνια



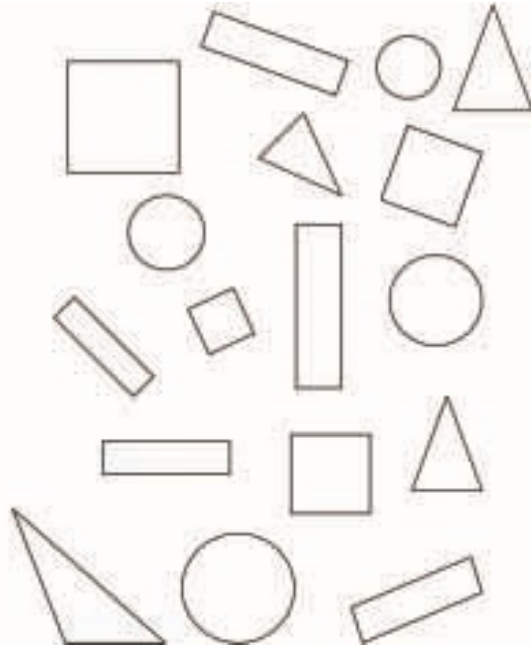

Χρωματίζω με το ίδιο χρώμα αυτά που μοιάζουν.

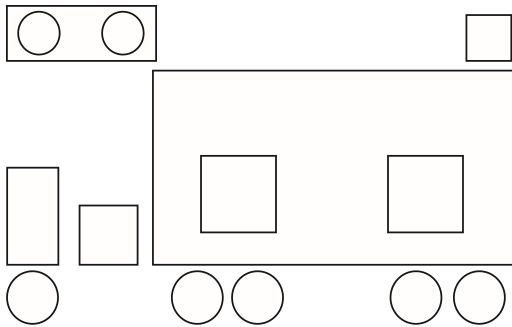

Μετρώ τα σχήματα που μοιάζουν μεταξύ τους και γράφω τους αντίστοιχους αριθμούς.



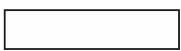

Υπάρχουν _____ 

Υπάρχουν _____ 

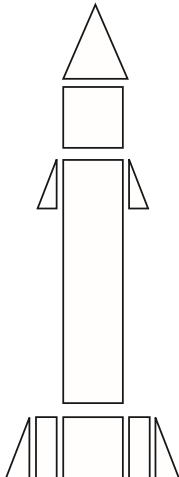
Υπάρχουν _____ 

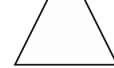

Υπάρχουν _____ 

Υπάρχουν _____ 

Υπάρχουν _____ 